

Century Aluminum Railings®

A DIVISION OF CENDEK RAILINGS LTD.

IT'S YOUR HOME. IT'S YOUR VIEW.
Distinctive, durable, long lasting beauty.

Scenic Railing



Picket Railing

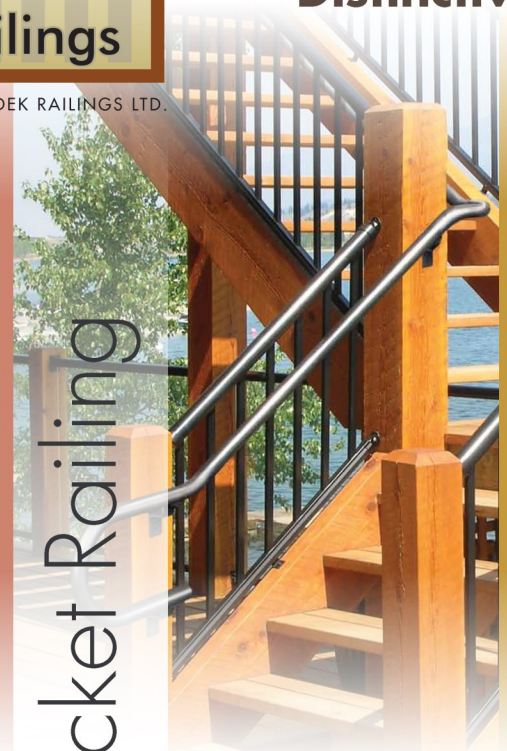

Glass Railing



Pipe Railing



Illustrated Catalogue
2017



Century Aluminum Railings are Designed for both the
Do-It-Yourselfer and Pro-Contractor Market

Century Aluminum Railings
9685 Agur Street
Summerland,
British Columbia, Canada
V0H 1Z2



Toll Free: 1 888 493 1103
Fax: 778 516 6003
centuryrailings.com

TABLE OF CONTENTS

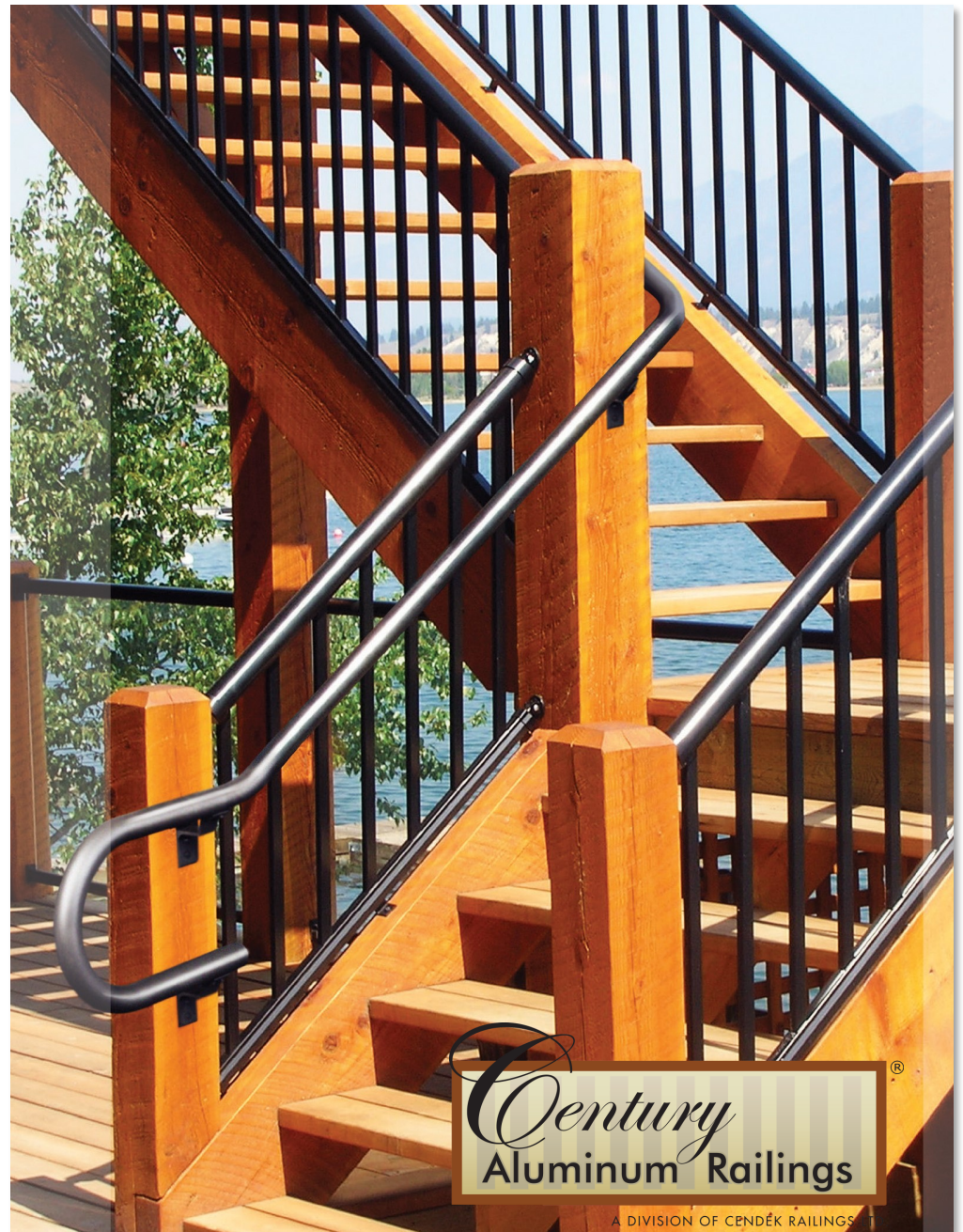
Top & Bottom Rails for 5/8" Picket	1
5/8" Pickets	2
5/8" 36" Pickets	3
1 1/2" Pickets for 42" Tall Railing	4
Top & Bottom Rails for 1 1/2" Pickets	5
Top & Bottom Rails for Glass	6
Clear Tempered Glass	6
Standard 42" Posts	7
Stair Line Posts	7
Adjustable 42" Posts	8
4" Maxum Post	8
36" Posts	9
Post Transition Bracket for Scenic Posts	10
Scenic 42" Posts	10
Fascia Mount Brackets	11
Fascia Support Legs	11
Fasteners (Lags & Screws)	12
Top Rail Sleeves	13
Wall Brackets	13
Swivel Brackets	13
Handrails	14
Handrail Brackets	14
Handrail End Caps	14
Support Legs	15
Baseplate Covers & Gasket	15
Adjustable Gate	16
Rubber Blocks	17
Touchup Pens	17
Picket Glass Conversion Kit	17
Welded Panels	18
Secondary Handrail & Accessories	19-21



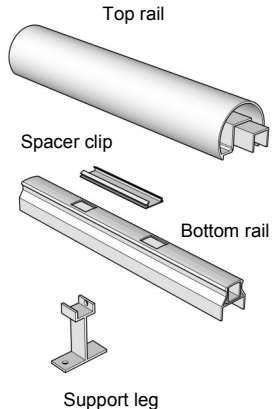



TOP & BOTTOM RAILS FOR 5/8" PICKETS

Product Code	Code	UPC Code	Product Description	Colour	Qty	Wt.lb.			
									
 Match rail letter in this column to corresponding picket letter on next page									
TBR6	A	873004000044	6' Top & Bottom Rails for 5/8" Pickets	White	pkg	7.47			
		873004000792		Black					
		873004003731		LS Copper					
TBR6	A								
		873004000013	6' Top & Bottom Rail for 5/8" Stair Picket	White	pkg	7.47			
		873004000761		Black					
873004003717	LS Copper								
TBR6	A								
		873004000112	8' Top & Bottom Rail for 5/8" Picket	White	pkg	9.82			
		873004000862		Black					
873004003786	LS Copper								
TBR6	A								
		873004000082	8' Top & Bottom Rail for 5/8" Stair Picket	White	pkg	9.82			
		873004000839		Black					
873004003762	LS Copper								
TBR6	A								
		873004000150	10' Top & Bottom Rail for 5/8" Picket	White	pkg	12.04			
		873004000907		Black					
873004003816	LS Copper								
TBR6	A								
		873004002741	10' Top & Bottom Rail for 5/8" Stair Picket	White	pkg	12.04			
		873004002789		Black					
873004004233	LS Copper								
TBR6	A								



Note: All Railing Packages include support leg(s) and spacer clips

Note: Product availability, description and subject to change without notice. Note: Always consult with your local building code prior to purchasing this product.

5/8" PICKET									
 5/8" x 37-7/8" picket	Product Code	Code	UPC Code	Product Description	Colour	Qty	Wt.lb.		
		 Match rail letter in this column to corresponding picket letter on page 1							
SP4	(C*2) (E*1)	436-01631	873004008200	4' Package of 5/8" Pickets	White	pkg	5.78		
		436-01632	873004008217		Black				
		436-01633	873004008231		LS Copper				
SP6	(A*1) (E*1)	436-00195	873004000235	6' Package of 5/8" Pickets	White	pkg	6.46		
		436-00190	873004001027		Black				
		436-00192	873004003861		LS Copper				

5/8" STAIR PICKET									
 5/8" x 31-7/8" picket	Product Code	Code	UPC Code	Product Description	Colour	Qty	Wt.lb.		
		 Match rail letter in this column to corresponding picket letter on page 1							
SSP4	(D*2) (F*1)	436-01634	873004008248	4' Package of 5/8" Stair Pickets	White	pkg	3.23		
		436-01635	873004008255		Black				
		436-01636	873004008279		LS Copper				
SSP6	(B*1) (F*1)	436-00233	873004000198	6' Package of 5/8" Stair Pickets	White	pkg	4.42		
		436-00227	873004000983		Black				
		436-00229	873004003847		LS Copper				
Note: Stair pickets are for 36" high stair railing									



5/8" PICKETS FOR 36" HIGH RAILING										
 5/8" x 31-7/8" picket	Product Code	Code	UPC Code	Product Description	Colour	Qty	Wt.lb.			
	 Match rail letter in this column to corresponding picket letter on page 1									
	SP4-36	(C*2) (E*1)	436-01874	873004008774	4' Package of 5/8" Pickets for 36" high rail	White	pkg	3.95		
			436-01875	873004008781		Black				
436-01876			873004008798	LS Copper						
SP6-36	(A*1) (E*1)	436-00736	873004003472	6' Package of 5/8" Pickets for 36" high rail	White	pkg	5.44			
		436-00737	873004003533		Black					
		436-00739	873004004318		LS Copper					



1 1/2" PICKET FOR 42" HIGH RAILING

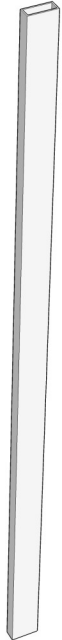



1 1/2" x 37-7/8" picket

Product Code	Code	UPC Code	Product Description	Colour	Qty	Wt.lb.				
		Match rail letter in this column to corresponding picket letter on page 5								
SWP4	(I*2) (K*1)		873004000266	4' Package of 1 1/2" Pickets	White	pkg	5.95			
			873004001058		Black					
			873004006909		LS Copper					
SSWP4	(J*2) (L*1)		873004000228	4' Package of 1 1/2" Stair Pickets	White	pkg	6.48			
			873004001010		Black					
			873004006916		LS Copper					
SWP6	(G*1) (K*1)	436-00982	873004000341	6' Package of 1 1/2" Pickets	White	pkg	9.10			
			436-00981		873004001133					Black
			436-00984		873004006947					LS Copper
SSWP6	(H*1) (L*1)		436-00970	6' Package of 1 1/2" Stair Pickets	White	pkg	7.70			
			436-00969		873004001096					Black
			436-00972		873004006954					LS Copper

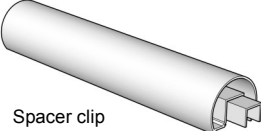
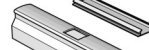
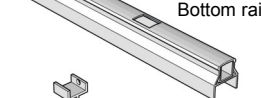

TOP & BOTTOM RAILS FOR 1 1/2" PICKETS

	Product Code	Code	UPC Code	Product Description	Colour	Qty	Wt.lb.			
		 Match rail letter in this column to corresponding picket letter on next page								
   	TBRW6	G	436-00958	873004000068	6' Top & Bottom Rails for 1 1/2" Pickets	pkg	7.47	White		
			436-00957	873004000815				Black		
			436-00960	873004006923				LS Copper		
	TBRWS6	H	436-00946	873004000037	6' Top & Bottom Rail for 1 1/2" Stair Picket	pkg	7.47	White		
			436-00945	873004000785				Black		
			436-00948	873004006930				LS Copper		
	TBRW8	I	436-00962	873004000136	8' Top & Bottom Rail for 1 1/2" Picket	pkg	9.82	White		
			436-00961	873004000884				Black		
			436-00964	873004006961				LS Copper		
	TBRWS8	J	436-00950	873004000105	8' Top & Bottom Rail for 1 1/2" Stair Picket	pkg	9.82	White		
436-00949			873004000853	Black						
436-00952			873004006978	LS Copper						
TBRW10	K	436-00966	873004000174	10' Top & Bottom Rail for 1 1/2" Picket	pkg	12.04	White			
		436-00965	873004000921				Black			
		436-00968	873004006886				LS Copper			
TBRWS10	L	436-00954	873004006800	10' Top & Bottom Rail for 1 1/2" Stair Picket	pkg	12.04	White			
		436-00953	873004006824				Black			
		436-00959	873004006879				LS Copper			
Note: All Railing Packages include support leg(s) and spacer clips										

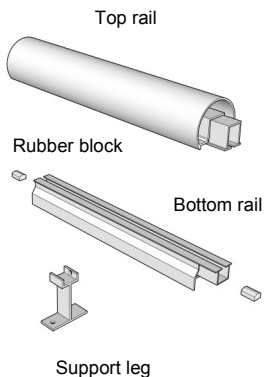

TOP & BOTTOM RAILS FOR GLASS (5MM-CANADA: 1/4"-USA)

	Product Code	Code	UPC Code	Product Description	Colour	Qty	Wt.lb.				
	TBRG6	436-00440	436-00440	873004000075	6' Top & Bottom Rails for 5/8" Glass	White	pkg	6.86			
		436-00434	436-00434	873004000822		Black					
		436-00436	436-00436	873004003755		LS Copper					
TBRG8	436-00446	436-00446	873004000143	8' Top & Bottom Rail for 5/8" Glass	White	pkg	9.07				
	436-00441	436-00441	873004000891		Black						
	436-00443	436-00443	873004003809		LS Copper						
TBRG10	436-00393	436-00393	873004000181	10' Top & Bottom Rail for 5/8" Glass	White	pkg	11.04				
	436-00388	436-00388	873004000938		Black						
	436-00390	436-00390	873004003830		LS Copper						

Note: All Railing Packages include support leg(s) and rubber blocks

CLEAR TEMPERED GLASS (5MM-CANADA: 1/4" - USA)

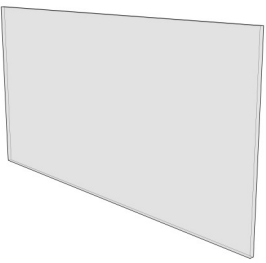
	Product Code	Code	UPC Code	Product Description	Colour	Qty	Wt.lb.				
	CTG24	436-00465	436-00465	873004000648	24" x 37 5/16" Clear Tempered Glass 1/4"	Clear	Each	18.24			
	CTG30	436-00466	436-00466	873004000655	30" x 37 5/16" Clear Tempered Glass 1/4"			22.80			
	CTG36	436-00467	436-00467	873004000662	36" x 37 5/16" Clear Tempered Glass 1/4"			27.36			
	CTG42	436-00468	436-00468	873004000679	42" x 37 5/16" Clear Tempered Glass 1/4"			31.92			
	CTG48	436-00469	436-00469	873004000686	48" x 37 5/16" Clear Tempered Glass 1/4"			36.48			
	CTG54	436-00470	436-00470	873004000693	54" x 37 5/16" Clear Tempered Glass 1/4"			41.04			
	CTG60	436-00471	436-00471	873004000709	60" x 37 5/16" Clear Tempered Glass 1/4"			45.60			
	CTG66	436-00472	436-00472	873004000716	66" x 37 5/16" Clear Tempered Glass 1/4"			50.16			
	CS24,30,36	436-00635	436-00635		Cardboard Sleeve for 24", 30" and 36" Glass			3.00			
CS42,48,54	436-00638	436-00638		Cardboard Sleeve for 42", 48" and 54" Glass			4.50				
CS60,66	436-00640	436-00640		Cardboard Sleeve for 60 and 66" Glass			5.50				

Note: Standard 5mm or 1/4" Clear Tempered Glass to be used with Century Railing System. Glass is shipped in cardboard sleeves with handles to protect each piece. Container quantities only.

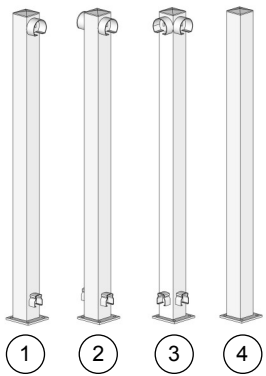

STANDARD 42" POSTS (2 1/2" X 2 1/2")											
 1. End Post 2. Line Post 3. Corner Post 4. Stair Post	Product Code	Code	UPC Code	Product Description	Colour	Qty	Wt.lb.				
	EP	1	436-00284	873004000426	End Post 42"	White	each	3.97			
			436-00278	873004001218		Black					
			436-00280	873004003977		LS Copper					
	LP	2	436-00306	873004000433	Line Post 42"	White	each	4.07			
			436-00300	873004001225		Black					
			436-00302	873004003984		LS Copper					
	CP	3	436-00262	873004000440	Corner Post 42"	White	each	4.07			
			436-00256	873004001232		Black					
			436-00258	873004003991		LS Copper					
	SP	4	436-00328	873004000419	Stair Post 42"	White	each	3.86			
			436-00322	873004001201		Black					
			436-00324	873004003960		LS Copper					
Note: Not for use with welded panels.											

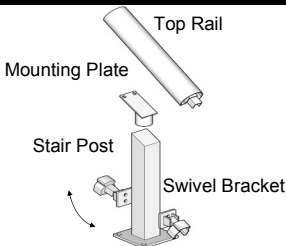
STAIR LINE POST (1 3/4" X 1 3/4")											
 Top Rail Mounting Plate Stair Post Swivel Bracket	Product Code	Code	UPC Code	Product Description	Colour	Qty	Wt.lb.				
	STLP		436-00565	873004006121	Stair Line Post	White	each	5.72			
			436-00566	873004006138		Black					
			436-00568	873004006169		LS Copper					
Note: Includes swivel brackets, accessories and instructions. Top rail sold separate.											



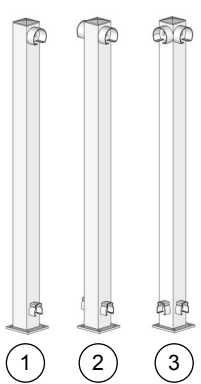

ADJUSTABLE 42" POST (2 1/2" X 2 1/2") FOR USE WITH WELDED PANELS									
Product Code	Code	UPC Code	Product Description	Colour	Qty	Wt.lb.			
EPWP	1	873004008361	End Post for Welded Panel	White	each	3.97			
		873004008378		Black					
		873004008392		LS Copper					
LPWP	2	873004008323	Line Post for Welded Panel	White	each	4.07			
		873004008330		Black					
		873004008354		LS Copper					
CPWP	3	873004008286	Corner Post for Welded Panel	White	each	4.07			
		873004008293		Black					
		873004008316		LS Copper					
 <p>1. End Post 2. Line Post 3. Corner Post</p> <p>Note: Posts include adjustable bottom sleeve for use with welded panels.</p>									

MAXUM POST 42" (4" X 4")									
Product Code	Code	UPC Code	Product Description	Colour	Qty	Wt.lb.			
MAXP4	436-01959	87300400922	Maxim Post 4"	White	each	9.2			
	436-01960	87300400923		Black					
	436-01961	87300400924		LS Copper					
 <p>Note: Post transition brackets needed to make the end, line or corner posts, .Baseplate cover N/A</p>									

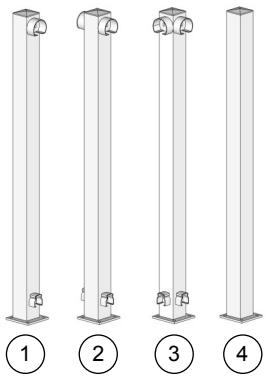

36" POSTS (2 1/2" X 2 1/2")									
Product Code	Code	UPC Code	Product Description	Colour	Qty	Wt.lb.			
EP36	1	436-00277	873004003326	End Post 36"	White	each	3.47		
		436-00275	873004003366		Black				
		436-00555	873004004288		LS Copper				
LP36	2	436-00299	873004003335	Line Post 36"	White	each	3.47		
		436-00297	873004003373		Black				
		436-00557	873004004295		LS Copper				
CP36	3	436-00255	873004003342	Corner Post 36"	White	each	3.47		
		436-00253	873004003380		Black				
		436-00556	873004004301		LS Copper				
SP36	4	436-00321	873004003311	Stair Post 36"	White	each	3.47		
		436-00319	873004003359		Black				
		436-00558	873004004271		LS Copper				
 <p>1. End Post 2. Line Post 3. Corner Post 4. Stair Post</p> <p>Note: Not for use with welded panels.</p>									



POST TRANSITION BRACKET FOR SCENIC POSTS										
 		Product Code	Code	UPC Code	Product Description	Colour	Qty	Wt.lb.		
PTB			436-00504	873004006060	Post Transition Bracket (with fasteners)	White	each	.30		
			436-00505	873004006077		Black				
			436-00621	873004006107		LS Copper				

SCENIC 42" POSTS (2 1/2" X 2 1/2") FOR 10MM GLASS(CANADA) 3/8" (USA)										
		Product Code	Code	UPC Code	Product Description	Colour	Qty	Wt.lb.		
SEP	1		436-00293	873004004370	Scenic End Post 42"	White	each	5.00		
			436-00289	873004004424		Black				
			436-00544	873004004578		LS Copper				
SLP	2		436-00315	873004004387	Scenic Line Post 42"	White	each	5.00		
			436-00311	873004004431		Black				
			436-00546	873004004585		LS Copper				
SCP	3		436-00271	873004004394	Scenic Corner Post 42"	White	each	5.00		
			436-00267	873004004448		Black				
			436-00545	873004004592		LS Copper				
SWP	4		436-00587	873004004417	Scenic Wall Post 42" (with fasteners)	White	each	5.00		
			436-00588	873004004462		Black				
			436-00591	873004004615		LS Copper				

Note: Wall posts can be used for attachments to columns or starting off against walls. Posts should be installed prior to ordering glass.

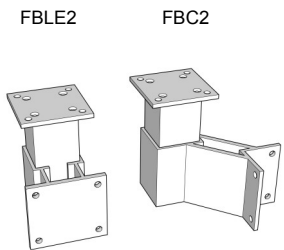
FASCIA MOUNT BRACKETS										
Product Code		Code	UPC Code	Product Description	Colour	Qty	Wt.lb.			
	FBLE2	436-01375	873004007630	Fascia line/end/stair bracket for standard post	White	each	2.26			
		436-01376	873004007647		Black					
		436-01377	873004007661		LS Copper					
	FBC2	436-01379	873004007678	Fascia outside 90 deg corner bracket for standard post	White	each	3.38			
		436-01380	873004007685		Black					
		436-01381	873004007708		LS Copper					
Note: Fasteners to connect post to bracket included. Fasteners to mount bracket to fascia sold separate.										

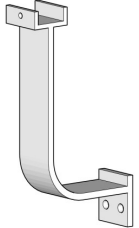
FASCIA SUPPORT LEG										
Product Code		Code	UPC Code	Product Description	Colour	Qty	Wt.lb.			
	FSL	436-00106	873004004707	Fascia support leg (with fasteners)	White	each	.44			
		436-00105	873004004790		Black					
		436-00620	873004005063		LS Copper					
	Note: To support bottom rail when fascia mount application required. Support leg should be installed every 18" to 24".									

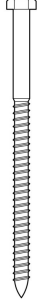
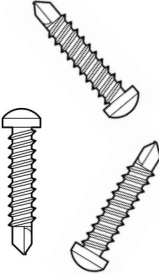
FASTENERS (LAGS & SCREWS)											
 4" lag	Product Code	Code	UPC Code	Product Description	Colour	Qty	Wt.lb.				
		SCP12C	436-00787	873004006688	4" x 5/16" lags (DT1700 Coating)	Coated	12/pk	.80			
	Note: Product is coated(DT1700) and is not painted, colored caps are not available for this item.										
	SCP12	436-00784	873004006503	4" x 5/16" lags Limited Availability	White						
		436-00783	873004006510		Black						
		436-00786	873004006541		LS Copper						
	SSCP12		873004006565	4" x 5/16" stainless steel lags (painted)	White	12/pk	.80				
			873004006572		Black						
			873004006602		LS Copper						
	CS50	436-0076	873004000471	#10 x 3/4" self tapping TEK screws		50/pk	.35				
			436-00070		873004001263						
			436-00072		873004004011						
	CSS50	436-01349	873004006626	#10 x 3/4" self tapping stainless steel TEK screws		50/pk	.35				
		436-01348	873004006633								
		436-01350	873004006664								
Note: Stainless steel fasteners should be used when installing railing near salt water.											

TOP RAIL SLEEVE

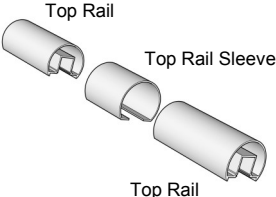
	Product Code	Code	UPC Code	Product Description	Colour	Qty	Wt.lb.				
	TRS	436-00581	436-00581	873004006305	Top Rail Sleeve (with fasteners)	White	each	.13			
		436-00582	436-00582	873004006312		Black					
		436-00584	436-00584	873004006343		LS Copper					
Note: For use with top rail when using stair railings with STLP (stair line post). Top rail sold separate.											

WALL BRACKETS

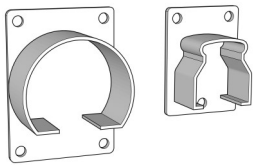
	Product Code	Code	UPC Code	Product Description	Colour	Qty	Wt.lb.				
	WB	436-00059	436-00059	873004000396	Top & bottom wall brackets (with fasteners)	White	set	.40			
		436-00053	436-00053	873004001188		Black					
		436-00055	436-00055	873004003946		LS Copper					
Note: Used to attach railing system to walls, columns and/or custom posts. Fasteners included (bracket to wall).											

SWIVEL BRACKETS

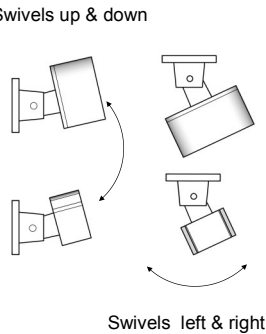
	Product Code	Code	UPC Code	Product Description	Colour	Qty	Wt.lb.				
	SB	436-00052	436-00052	873004000402	Swivel brackets	White	Set	.90			
		436-00046	436-00046	873004001195		Black					
		436-00048	436-00048	873004003953		LS Copper					
	SBS	436-01352	436-01352	873004006985	Swivel brackets (with stainless steel fasteners)	White	set	.90			
		436-01353	436-01353	873004006992		Black					
		436-01354	436-01354	873004007029		LS Copper					
Note: Adjusts to all stair inclines. Includes top & bottom brackets, fasteners, and instructions. Note: Fasteners should be lubricated during installation to prevent damage.											

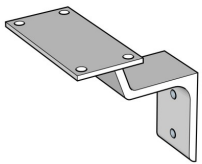

HANDRAIL										
	Product Code	Code	UPC Code	Product Description	Colour	Qty	Wt.lb.			
	TRL6	436-00485	873004000617	6' Handrail	White	each	6.00			
		436-00480	873004001393		Black					
		436-00482	873004004097		LS Copper					
	TRL8	436-00491	873004000624	8' Handrail	White	each	8.00			
		436-00486	873004001409		Black					
		436-00488	873004004103		LS Copper					
	TRL10	436-00616	873004000631	10' Handrail	White	each	10.00			
		436-00615	873004001416		Black					
			873004004110		LS Copper					
Note: End cap, handrail brackets and fasteners sold separate.										

HANDRAIL BRACKET										
	Product Code	Code	UPC Code	Product Description	Colour	Qty	Wt.lb.			
	HRB	436-00045	873004000600	Handrail brackets (with fasteners)	White	each	.40			
		436-00040	873004001386		Black					
		436-00042	873004004080		LS Copper					

HANDRAIL END CAP										
	Product Code	Code	UPC Code	Product Description	Colour	Qty	Wt.lb.			
	HR	436-00135	873004000594	Handrail end cap (with fasteners)	White	each	.20			
		436-00130	873004001379		Black					
		436-00132	873004004073		LS Copper					

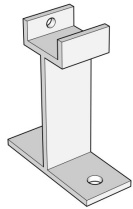

SUPPORT LEG											
	Product Code	Code	UPC Code	Product Description	Colour	Qty	Wt.lb.				
	SL	436-01698	873004000518	Bottom rail support leg		White	each	.12			
		436-01699	873004001300			Black					
		436-01700	Special order			LS Copper					
Note: Not sold in retail packaging.											

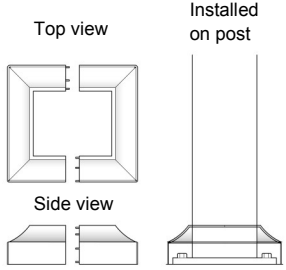
BASE PLATE COVER											
	Product Code	Code	UPC Code	Product Description	Colour	Qty	Wt.lb.				
	BPC 2 1/2"	436-00577	873004006183	Baseplate cover 2 1/2"		White	each	.13			
		436-00578	873004006190			Black					
		436-00580	873004006220			LS Copper					
	BPC 1 3/4"	436-00573	873004006244	Baseplate cover 1 3/4" (for use with STLP)		White	each	.13			
		436-00574	873004006251			Black					
		436-00576	873004006282			LS Copper					
Note: Post(s) not included. * Not available in custom colors											

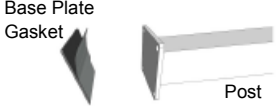
BASE PLATE GASKET											
	Product Code	Code	UPC Code	Product Description	Colour	Qty	Wt.lb.				
	BPG5		87300409542	Baseplate gasket 6"x6" (5 per pack)		each	.10				
	BPG10	436-01982	873004009214	Baseplate gasket 4"x4" (10 per pack)		each	.09				
Note: Post(s) not included.											

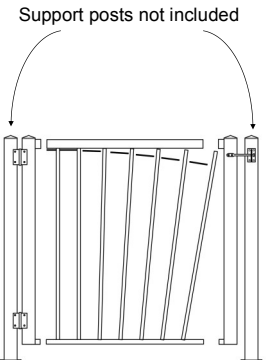
ADJUSTABLE GATE										
Product Code	Code	UPC Code	Product Description	Colour	Qty	Wt.lb.				
SPG	436-00123	873004000556	Straight 5/8" picket gate (42" high system)	White	each	21.00				
	436-00118	873004001331		Black						
	436-00120	873004004059		LS Copper						
SWPG		Special order	Straight 1 1/2" picket gate (42" high system)	White	each	21.00				
		Special order		Black						
		Special order		LS Copper						
SPG36	436-00117	Special order	Straight 5/8" picket gate (36" high system)	White	each	21.00				
	436-00115	Special order		Black						
	436-01544	Special order		LS Copper						
SWPG36		Special order	Straight 1 1/2" picket gate (36" high system)	White	each	21.00				
		Special order		Black						
		Special order		LS Copper						
 <p>Note: Gates are designed to fit openings 24"-48". Black hinges and latch are included. Support posts are not included. Gates are unassembled and boxed.</p>										

RUBBER BLOCKS

	Product Code	Code	UPC Code	Product Description	Colour	Qty	Wt.lb.			
	RB10	436-00340	873004000525	Rubber blocks for glass	Black	10/pk	.10			
Note: Install two blocks per sheet of glass, in bottom track only prior to installing bottom rail.										

TOUCH UP PENS

	Product Code	Code	UPC Code	Product Description	Colour	Qty	Wt.lb.			
	TUPP	436-00502	873004000501	Touch up pen	White	each	.06			
		436-00503	873004001294		Black					
		436-00501	873004004028		LS Copper					

PICKET / GLASS CONVERSION KIT

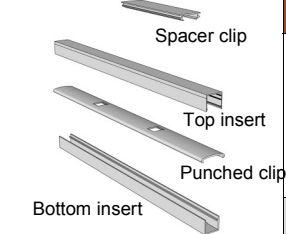
	Product Code	Code	UPC Code	Product Description	Colour	Qty	Wt.lb.			
	PICGLA	436-01406	873004000803	Picket / Glass combo pack	White	each	3.00			
		436-01407	873004000804		Black					
		436-01440	873004000806		LS Copper					
Note: Includes 4' punched bottom rail clip, 4' top & bottom rail picket insert, 12 spacer clips. DOES NOT INCLUDE PICKETS OR TOP & BOTTOM RAIL										

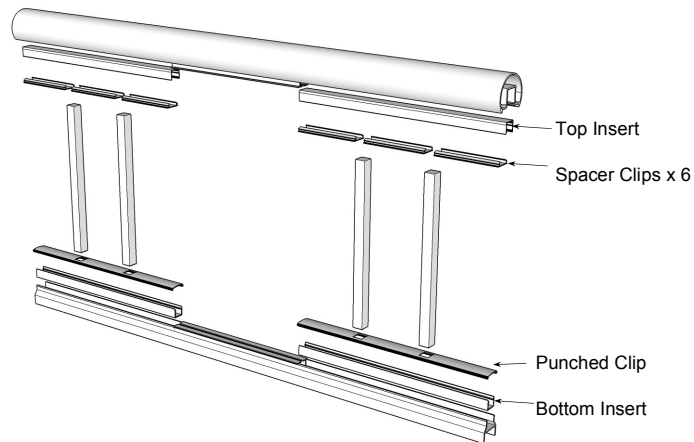

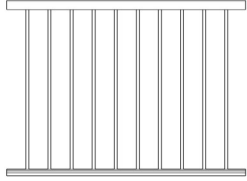
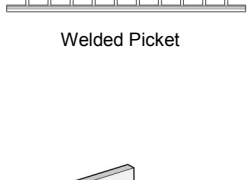
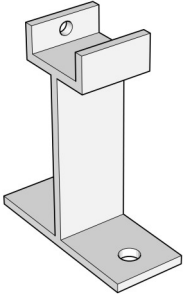
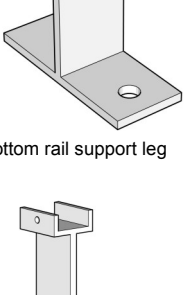
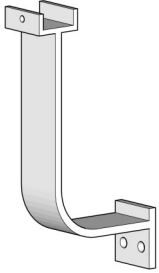
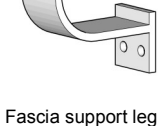
WELDED PANELS										
	Product Code	Code	UPC Code	Product Description	Colour	Qty	Wt.lb.			
 <p>Welded Picket</p>	WPL8	436-00714	873004000642	42" Welded 5/8" picket panel x 8'	White	each	22.00			
		436-00715	873004000643		Black					
		436-00716	873004007487		LS Copper					
 <p>Welded Picket</p>	WPL12	436-00717	873004000646	42" Welded 5/8 picket panel x 12'	White	each	33.00			
		436-00718	873004000647		Black					
		436-00719	873004007548		LS Copper					
 <p>Bottom rail support leg</p>	WWPL8	436-01691	873004000644	42" Welded 1 1/2" picket panel x 8'	White	each	24.00			
		436-01523	873004000645		Black					
		436-01974	Special order		LS Copper					
 <p>Bottom rail support leg</p>	WWPL12	436-01693	873004000646	42" Welded 1 1/2" picket panel x 12'	White	each	36.00			
		436-01525	873004000649		Black					
		436-01975	Special order		LS Copper					
 <p>Fascia support leg</p>	SL	436-01698	873004000518	Bottom rail support leg (deck mount)	White	each	.12			
		436-01699	873004001300		Black					
		436-01700	Special order		LS Copper					
<p>Note: Each panel opening between posts requires a support leg. Additional support legs are required where there is more than 3' between support leg and post. NOT SOLD IN RETAIL PACKAGING.</p>										
 <p>Fascia support leg</p>	FSL	436-00106	873004004707	Fascia support leg (with fasteners)	White	each	.44			
		436-00105	873004004790		Black					
		436-00620	873004005063		LS Copper					
<p>Note: Support leg (s) not included with welded panels and should be purchased separately.</p>										



SECONDARY HANDRAIL & ASSESSORIES										
Product Code	Code	UPC Code	Product Description	Colour	Qty	Wt.lb.				
PHR6	436-01408	873004007036	6' Pipe handrail kit	White	each	6.10				
	436-01409	873004007043		Black						
	436-01410	873004007067		LS Copper						
PHR8	436-01412	873004007074	8' Pipe handrail kit	White	each	8.00				
	436-01413	873004007081		Black						
	436-01414	873004007104		LS Copper						
Note: Pipe handrail kit includes pipe rail (to length), two end caps, two handrail brackets and all required fasteners For commercial applications 10' and 20' lengths are available (not packaged for retail sale) P.O.R.										
PHRB	436-01486	873004007357	Pipe handrail bracket	White	each	.30				
	436-01472	873004007364		Black						
	436-01473	873004007388		LS Copper						
Note: For attaching handrail to posts or walls. Includes fasteners.										
PHRC	436-01474	873004007395	Pipe handrail end cap	White	each	.20				
	436-01475	873004007401		Black						
	436-01476	873004007425		LS Copper						
Note: For capping off end of handrail. Includes fasteners.										
PHRS	436-00528	873004008194	Pipe handrail splice (not painted)		each	.50				
Note: Internal splice for joining handrail, returns and extensions together.										

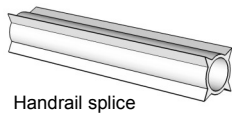
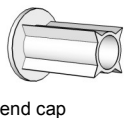
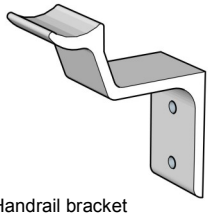
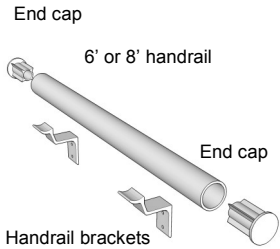

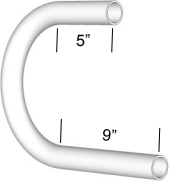
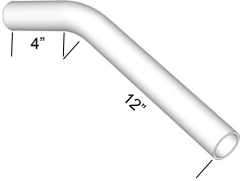
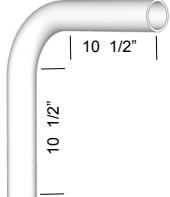
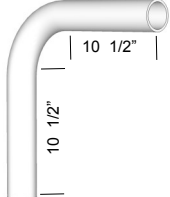
SECONDARY HANDRAIL & ASSESSORIES									
Product Code	Code	UPC Code	Product Description	Colour	Qty	Wt.lb.			
PHRR180	436-01405	873004007319	180° Pipe Handrail Return	White	each	4.00			
	436-01465	873004007326		Black					
	436-01471	873004007340		LS Copper					
 <p>180° Pipe handrail return</p> <p>Note: For use at post locations at top and bottom of stairs where a handrail return is required. Requires 1-PHRC, 1-PHRS, 2-PHRB.</p>									
PHRE32	436-00812	873004007197	32° Handrail Extension	White	each	2.00			
	436-01463	873004007203		Black					
	436-01468	873004007227		LS Copper					
 <p>Handrail extension</p> <p>Note: Allows for 1 ft. extension at top or bottom of stairs.</p>									
PHRE35	436-01404	873004007234	35° Handrail Extension	White	each	2.00			
	436-01462	873004007241		Black					
	436-01470	873004007265		LS Copper					
 <p>90° Handrail extension</p> <p>Note: Allows for 1 ft. extension at top or bottom of stairs.</p>									
PHRE90	436-00811	873004007272	90° Handrail Extension	White	each	2.00			
	436-01464	873004007289		Black					
	436-01469	873004007302		LS Copper					
 <p>90° Handrail extension</p> <p>Note: For returning into wall at top and bottom of stairs.</p>									
	Special Order	Custom	Custom Handrail Extension		each				

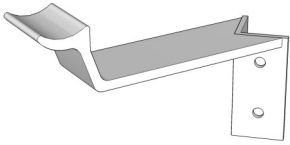
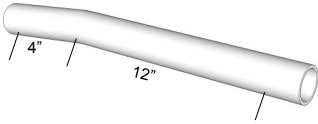
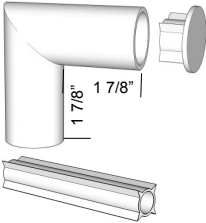

SECONDARY HANDRAIL & ASSESSORIES

	Product Code	Code	UPC Code	Product Description	Colour	Qty	Wt.lb.			
 <p>90° Pipe handrail bracket</p>	PHRB90	436-01486	87300400930	90° Pipe Hand Rail Bracket (inside)	White	each				
		436-01472	87300400931		Black					
		436-01473	87300400932		LS Copper					
<p>Note: For use at corner post locations where a handrail is required.</p>										
 <p>Handrail extension</p>	PHRE6	436-02090	87300400934	6° Pipe Handrail Extension	White	each				
		436-02091	87300400935		Black					
		436-02092	87300400936		LS Copper					
<p>Note: Allows for 1 ft. extension at top or bottom of ramps</p>										
 <p>90° Handrail extension</p>	PHRMR90	436-02093	87300400938	90° Pipe Handrail mitered return	White	each				
		436-02094	87300400938		Black					
		436-02095	87300400940		LS Copper					
<p>Note: For returning into wall at top and bottom of stairs. 3 Parts included</p>										

